

## PIM with Trench Field-Stop IGBT, Emitter Controlled Diode and NTC

### Features

- $V_{CE}=1200V$   $I_C=50A$
- Low  $V_{CE(sat)}$  with Positive Temperature Coefficient
- Trench+ Field Stop Technology

### Applications

- The inverter
- Motor control and drives
- Auxiliary Inverters

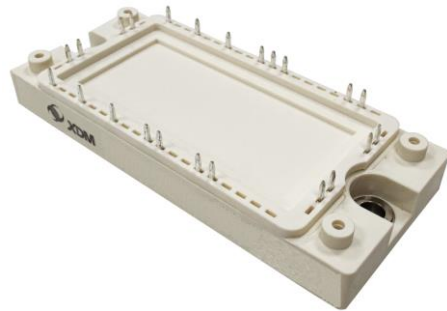

### Equivalent Circuit Schematic

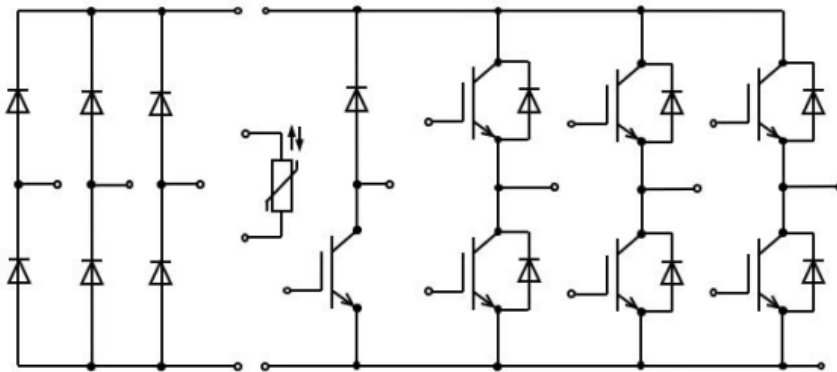

### IGBT - Inverter

#### Maximum Rated Values

Symbol	Description	Conditions	Values	Unit
$V_{CES}$	Collector-Emitter Voltage	$T_{vj}=25^{\circ}C$	1200	V
$V_{GES}$	Gate-Emitter Peak Voltage	$T_{vj}=25^{\circ}C$	$\pm 20$	V
$I_C$	Continuous DC Collector Current	$T_C=100^{\circ}C$	50	A
$I_{CRM}$	Repetitive Peak Collector Current	$t_p=1ms$	100	A
$P_{tot}$	Total Power Dissipation	$T_C=25^{\circ}C, T_{vj\ max}=175^{\circ}C$	326	W

**Characteristic Values**

Symbol	Description	Conditions	Values			Unit
			Min.	Typ.	Max.	
$V_{CE(sat)}$	Collector-Emitter Saturation Voltage	$V_{GE}=15V, I_C=50A, T_{vj}=25^{\circ}C$	---	1.86	--	V
		$V_{GE}=15V, I_C=50A, T_{vj}=125^{\circ}C$	---	2.16	--	V
$V_{GE(th)}$	Gate Threshold Voltage	$V_{GE}=V_{CE}, I_C=1.7mA$	5.0	5.7	6.8	V
$I_{CES}$	Collector-Emitter Cut-Off Current	$V_{CE}=1200V, V_{GE}=0V$	---	---	1.0	mA
$I_{GES}$	Gate-Emitter Leakage Current	$V_{GE}=20V, V_{CE}=0V$	---	---	750	nA
$R_{Gint}$	Internal gate resistor	$T_{vj}=25^{\circ}C$	---	4.0	---	$\Omega$
$C_{ies}$	Input Capacitance	$V_{CE}=25V, V_{GE}=0V, f=1MHz$	---	3.8	---	nF
$C_{res}$	Reverse Transfer Capacitance		---	0.14	---	nF
$t_{d(on)}$	Turn-on Delay Time	$V_{CC}=600V$ $V_{GE}=\pm 15V$ $I_C=50A$ $R_G=15\Omega$ Inductive Load $T_{vj}=25^{\circ}C$	---	92	---	ns
$t_r$	Turn-on Rise Time		---	50	---	ns
$t_{d(off)}$	Turn-off Delay Time		---	269	---	ns
$t_f$	Turn-off Fall Time		---	135	---	ns
$E_{on}$	Turn-on Switching Loss		---	5.3	---	mJ
$E_{off}$	Turn-off Switching Loss		---	3.4	---	mJ
$I_{SC}$	Short Circuit data	$V_{GE}\leq 15V, V_{CC}=800V$ $t_p\leq 10\mu s, T_{vj}=25^{\circ}C$	---	136	---	A
$R_{thJC}$	Thermal Resistance, Junction to Case	Per IGBT	---	0.46	---	K/W
$T_{VJOP}$	Virtual Junction Temperature	Under Switching	-40	---	150	$^{\circ}C$

**Diode - Inverter  
Maximum Rated Values**

Symbol	Description	Conditions	Values	Unit
$V_{RRM}$	Repetitive Peak Reverse Voltage	$T_{vj}=25^{\circ}C$	1200	V
$I_F$	Continuous DC Forward Current		50	A
$I_{FRM}$	Repetitive Peak Collector Current	$t_p=1ms$	100	A

**Characteristic Values**

Symbol	Description	Conditions	Values			Unit
			Min.	Typ.	Max.	
V <sub>F</sub>	Forward Voltage	I <sub>F</sub> =50A, V <sub>GE</sub> =0V, T <sub>vj</sub> =25°C	---	2.06	---	V
		I <sub>F</sub> =50A, V <sub>GE</sub> =0V, T <sub>vj</sub> =125°C	---	1.84	---	V
I <sub>RM</sub>	Peak Reverse Recovery Current	I <sub>F</sub> =50A, di/dt=988A/us V <sub>R</sub> =600V, V <sub>GE</sub> =-15V T <sub>vj</sub> =25°C	---	18	---	A
Q <sub>r</sub>	Recovered Charge		---	4.4	---	uC
E <sub>rec</sub>	Reverse Recovery Energy		---	1.8	---	mJ
T <sub>VJ OP</sub>	Virtual Junction Temperature	Under Switching	-40	---	150	°C

**Diode - Rectifier  
Maximum Rated Values**

Symbol	Description	Conditions	Values	Unit
V <sub>RRM</sub>	Repetitive Peak Reverse Voltage	T <sub>vj</sub> =25°C	1600	V
I <sub>FAV</sub>	Average Forward Current		30	A
I <sub>FSM</sub>	Surge Forward Current	t <sub>p</sub> =10ms	360	A
I <sup>2</sup> t	I <sup>2</sup> t Value	t <sub>p</sub> =10ms, sin180°, T <sub>J</sub> =25°C	648	A <sup>2</sup> s

**Characteristic Values**

Symbol	Description	Conditions	Values			Unit
			Min.	Typ.	Max.	
V <sub>F</sub>	Forward Voltage	I <sub>F</sub> =50A, V <sub>GE</sub> =0V, T <sub>vj</sub> =25°C	---	1.18	---	V
I <sub>R</sub>	Recovery Current	V <sub>R</sub> =1600V, T <sub>vj</sub> =25°C	---	10	---	uA
T <sub>VJ OP</sub>	Virtual Junction Temperature	Under Switching	-40	---	150	°C

## IGBT – Brake

### Maximum Rated Values

Symbol	Description	Conditions	Values	Unit
$V_{CES}$	Collector-Emitter Voltage	$T_{vj}=25^{\circ}\text{C}$	1200	V
$V_{GES}$	Gate-Emitter Peak Voltage	$T_{vj}=25^{\circ}\text{C}$	$\pm 20$	V
$I_C$	Continuous DC Collector Current	$T_C=100^{\circ}\text{C}$	25	A
$I_{CRM}$	Repetitive Peak Collector Current	$t_p=1\text{ms}$	50	A

### Characteristic Values

Symbol	Description	Conditions	Values			Unit
			Min.	Typ.	Max.	
$V_{CE(sat)}$	Collector-Emitter Saturation Voltage	$V_{GE}=15\text{V}, I_C=25\text{A}, T_{vj}=25^{\circ}\text{C}$	---	1.64	--	V
		$V_{GE}=15\text{V}, I_C=25\text{A}, T_{vj}=125^{\circ}\text{C}$	---	1.90	--	V
$V_{GE(th)}$	Gate Threshold Voltage	$V_{GE}=V_{CE}, I_C=1.2\text{mA}$	5.2	5.8	6.4	V
$I_{CES}$	Collector-Emitter Cut-Off Current	$V_{CE}=1200\text{V}, V_{GE}=0\text{V}$	---	---	1	mA
$I_{GES}$	Gate-Emitter Leakage Current	$V_{GE}=15\text{V}, V_{CE}=0\text{V}$	---	---	450	nA
$R_{Gint}$	Internal gate resistor	$T_{vj}=25^{\circ}\text{C}$	---	2.5	---	$\Omega$
$C_{ies}$	Input Capacitance	$V_{CE}=25\text{V}, V_{GE}=0\text{V}, f=1\text{MHz}$	---	1.5	---	nF
$C_{res}$	Reverse Transfer Capacitance		---	0.08	---	nF
$t_{d(on)}$	Turn-on Delay Time	$V_{CC}=600\text{V}$ $V_{GE}=\pm 15\text{V}$ $I_C=25\text{A}$ $R_G=39\Omega$ Inductive Load $T_{vj}=25^{\circ}\text{C}$	---	106	---	ns
$t_r$	Turn-on Rise Time		---	38	---	ns
$t_{d(off)}$	Turn-off Delay Time		---	448	---	ns
$t_f$	Turn-off Fall Time		---	139	---	ns
$E_{on}$	Turn-on Switching Loss		---	2.7	---	mJ
$E_{off}$	Turn-off Switching Loss		---	2.3	---	mJ
$T_{VJ OP}$	Virtual Junction Temperature	Under Switching	-40	---	150	$^{\circ}\text{C}$

## Diode - Brake

### Maximum Rated Values

Symbol	Description	Conditions	Values	Unit
$V_{RRM}$	Repetitive Peak Reverse Voltage	$T_{vj}=25^{\circ}\text{C}$	1200	V
$I_F$	Continuous DC Forward Current		15	A
$I_{FRM}$	Repetitive Peak Collector Current	$t_p=1\text{ms}$	30	A

### Characteristic Values

Symbol	Description	Conditions	Values			Unit
			Min.	Typ.	Max.	
$V_F$	Forward Voltage	$I_F=15\text{A}, V_{GE}=0\text{V}, T_{vj}=25^{\circ}\text{C}$	---	2.10	---	V
		$I_F=15\text{A}, V_{GE}=0\text{V}, T_{vj}=125^{\circ}\text{C}$	---	1.71	---	V
$I_{RM}$	Peak Reverse Recovery Current	$I_F=15\text{A}, V_R=600\text{V}, T_{vj}=25^{\circ}\text{C}$	---	18.4	---	A
$Q_r$	Recovered Charge		---	1.8	---	$\mu\text{C}$
$E_{rec}$	Reverse Recovery Energy		---	0.6	---	mJ
$T_{VJOP}$	Virtual Junction Temperature	Under Switching	-40	---	150	$^{\circ}\text{C}$

## NTC-Thermistor

### Characteristic Values

Symbol	Description	Conditions	Values			Unit
			Min.	Typ.	Max.	
$R_{25}$	Rated Resistance	$T_C=25^{\circ}\text{C}$	---	5	---	$\text{K}\Omega$
$B_{25/50}$	B Value	$R_2 = R_{25} \exp [B_{25/50}(1/T_2 - 1/(298 \text{ K}))]$	---	3380	---	K

**Module**

Symbol	Description	Conditions	Values	Unit
$V_{ISOL}$	Isolation Test Voltage	RMS, f=50Hz, t=1min	4	KV
	Internal Isolation	Basic Insulation (Class 1, IEC 61140)	$Al_2O_3$	
	Creepage Distance	Terminal to Terminal	10.1	mm
	Clearance	Terminal to Terminal	7.5	mm

Symbol	Description	Conditions	Values			Unit
			Min.	Typ.	Max.	
$L_{sCE}$	Stray Inductance Module		---	36	---	nH
$T_{stg}$	Storage Temperature		-40	---	125	°C
G	Weight		---	175	---	g

# Typical Characteristics

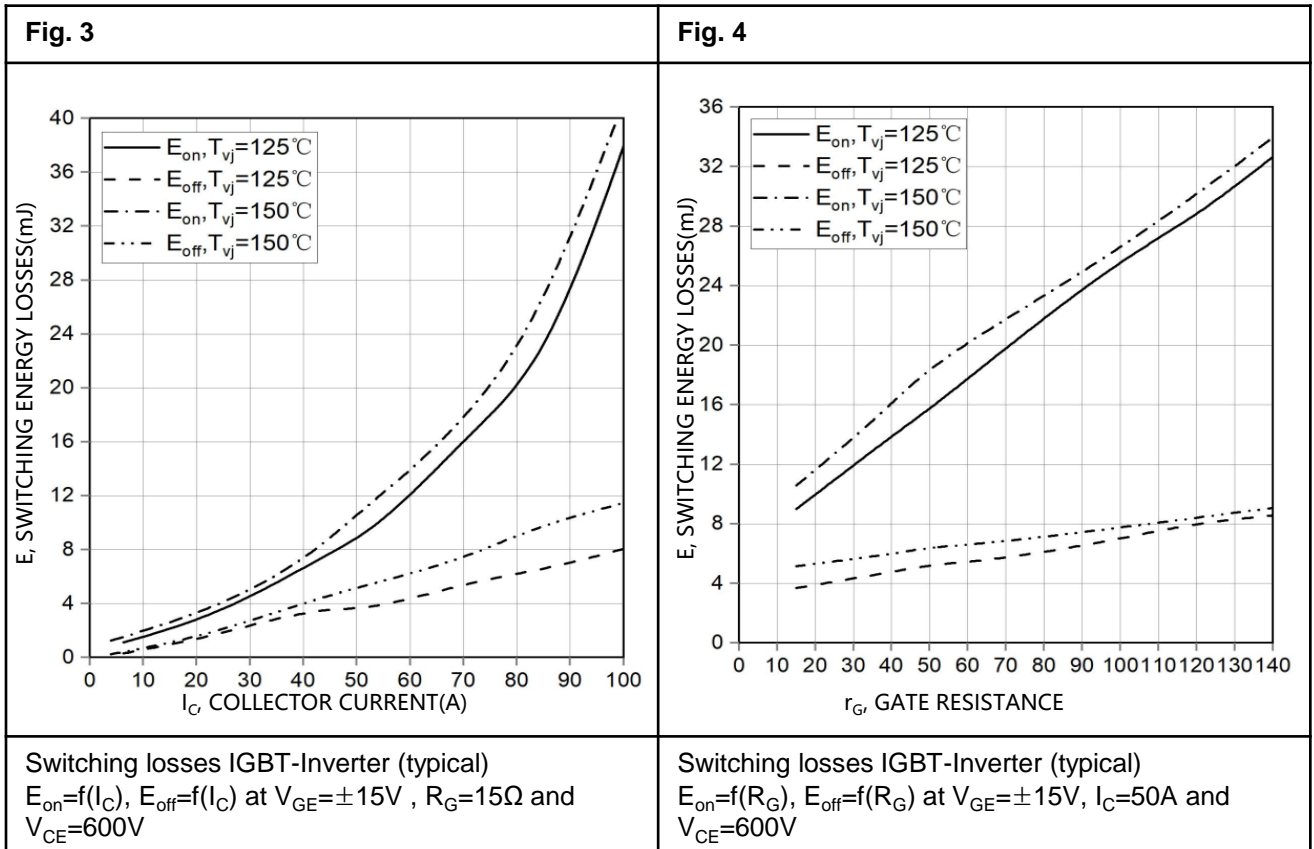
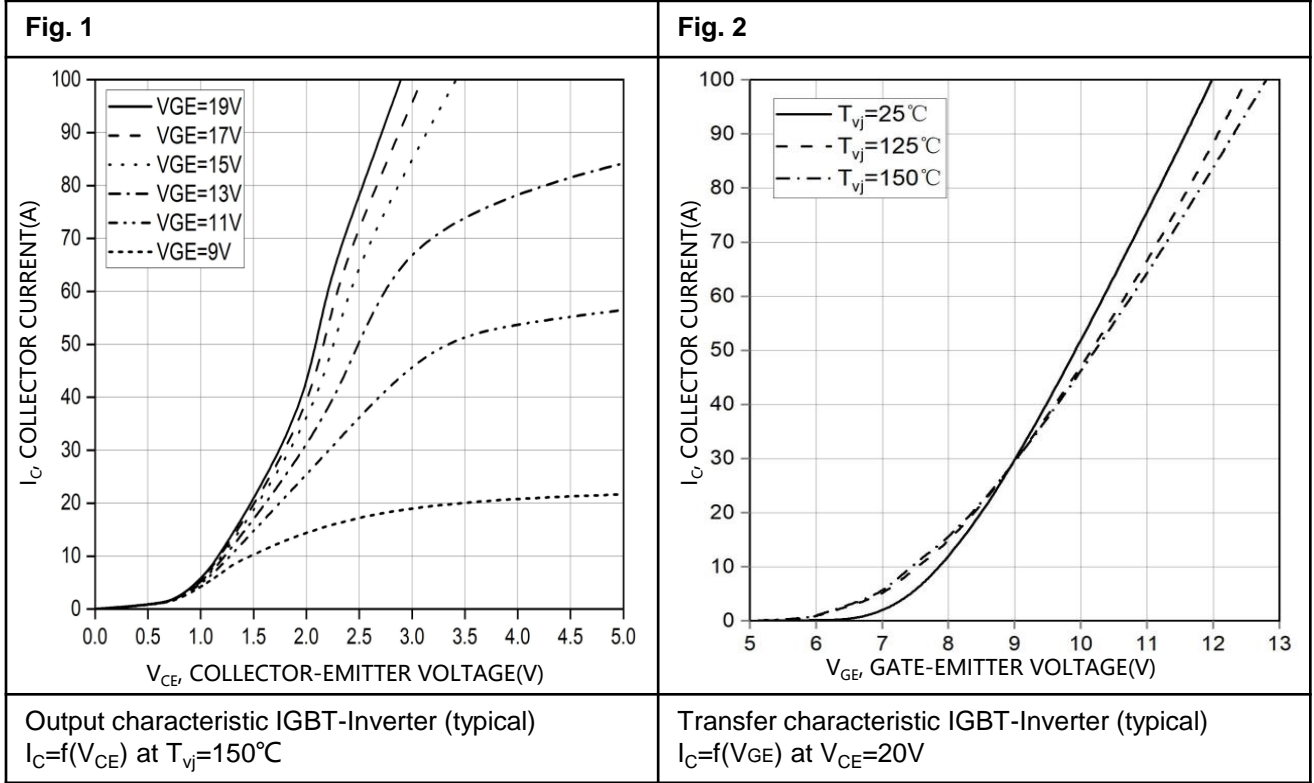

# Typical Characteristics

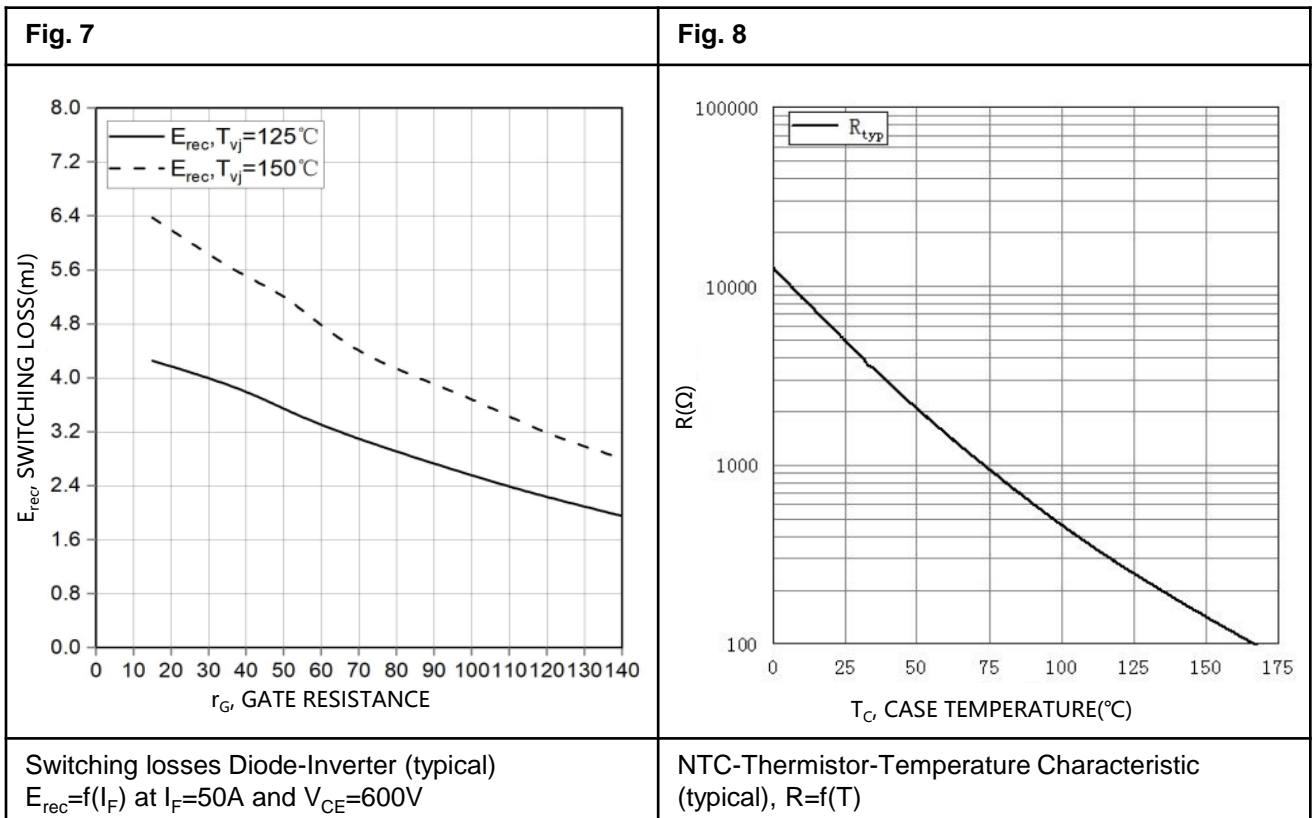
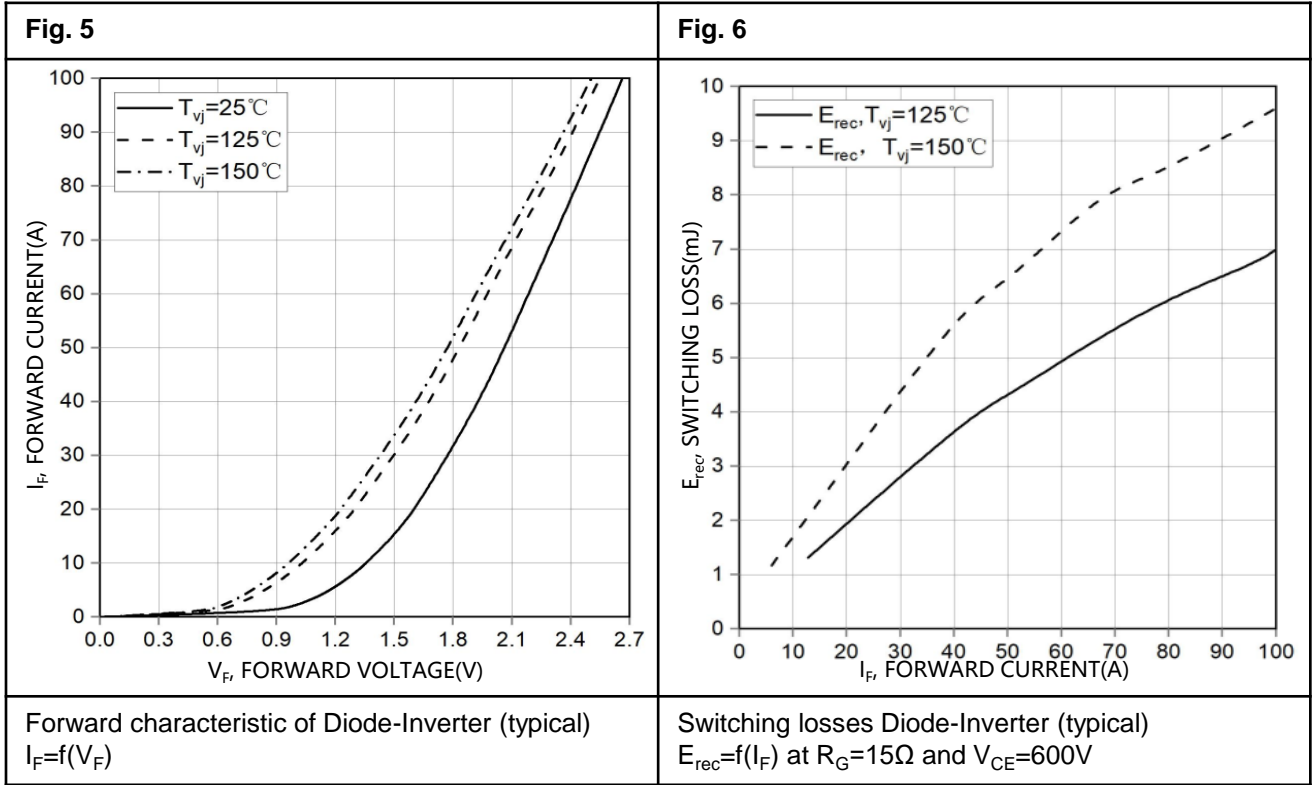



### Circuit Diagram

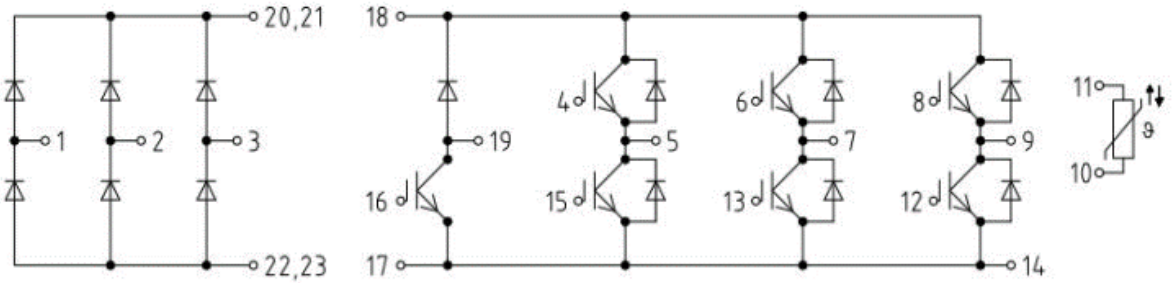

### Package Outlines (mm)

